

S/4HANA Roadmap Update & 2023 Release Highlights

Zach Vernon

S/4HANA Cloud Solution Advisor & Evangelist
North America S/4HANA Center of Excellence

Public

S/4HANA Turns 9!



THE BEST RUN



Agenda

1

S/4HANA

Where we are now – 9TH major release

2

S/4HANA Maintenance & Release Strategy

2023 introduces a change in our release strategy moving forward

3

S/4HANA 2023 Innovations

Innovation summary and highlights from 2023 release and additional resources

Disclaimer

The information in this presentation is confidential and proprietary to SAP and may not be disclosed without the permission of SAP. Except for your obligation to protect confidential information, this presentation is not subject to your license agreement or any other service or subscription agreement with SAP. SAP has no obligation to pursue any course of business outlined in this presentation or any related document, or to develop or release any functionality mentioned therein.

This presentation, or any related document and SAP's strategy and possible future developments, products and or platforms directions and functionality are all subject to change and may be changed by SAP at any time for any reason without notice. The information in this presentation is not a commitment, promise or legal obligation to deliver any material, code or functionality. This presentation is provided without a warranty of any kind, either express or implied, including but not limited to, the implied warranties of merchantability, fitness for a particular purpose, or non-infringement. This presentation is for informational purposes and may not be incorporated into a contract. SAP assumes no responsibility for errors or omissions in this presentation, except if such damages were caused by SAP's intentional or gross negligence.

All forward-looking statements are subject to various risks and uncertainties that could cause actual results to differ materially from expectations. Readers are cautioned not to place undue reliance on these forward-looking statements, which speak only as of their dates, and they should not be relied upon in making purchasing decisions.

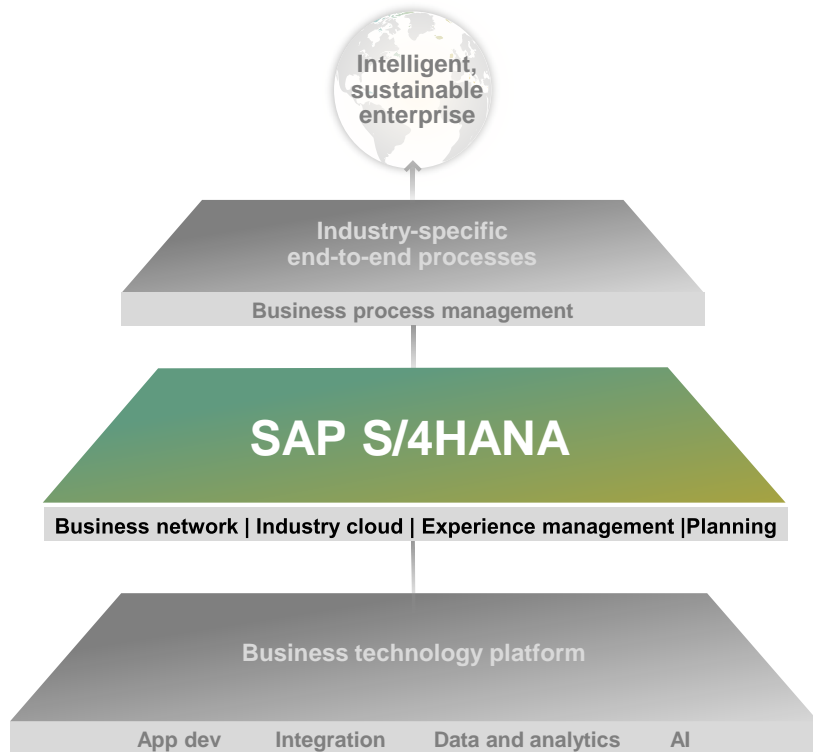

SAP S/4HANA is the **product family** of SAP's modern ERP Offerings, which are at the core of the intelligent, sustainable enterprise.

SAP S/4HANA is delivered in three distinct product flavors:

- SAP S/4HANA Cloud, public edition
- SAP S/4HANA Cloud, private edition
- SAP S/4HANA

The change in strategy described in the following slides only effects solutions in the SAP S/4HANA Cloud, private edition family and SAP S/4HANA (on-premise).

SAP S/4HANA: Where We Are Now

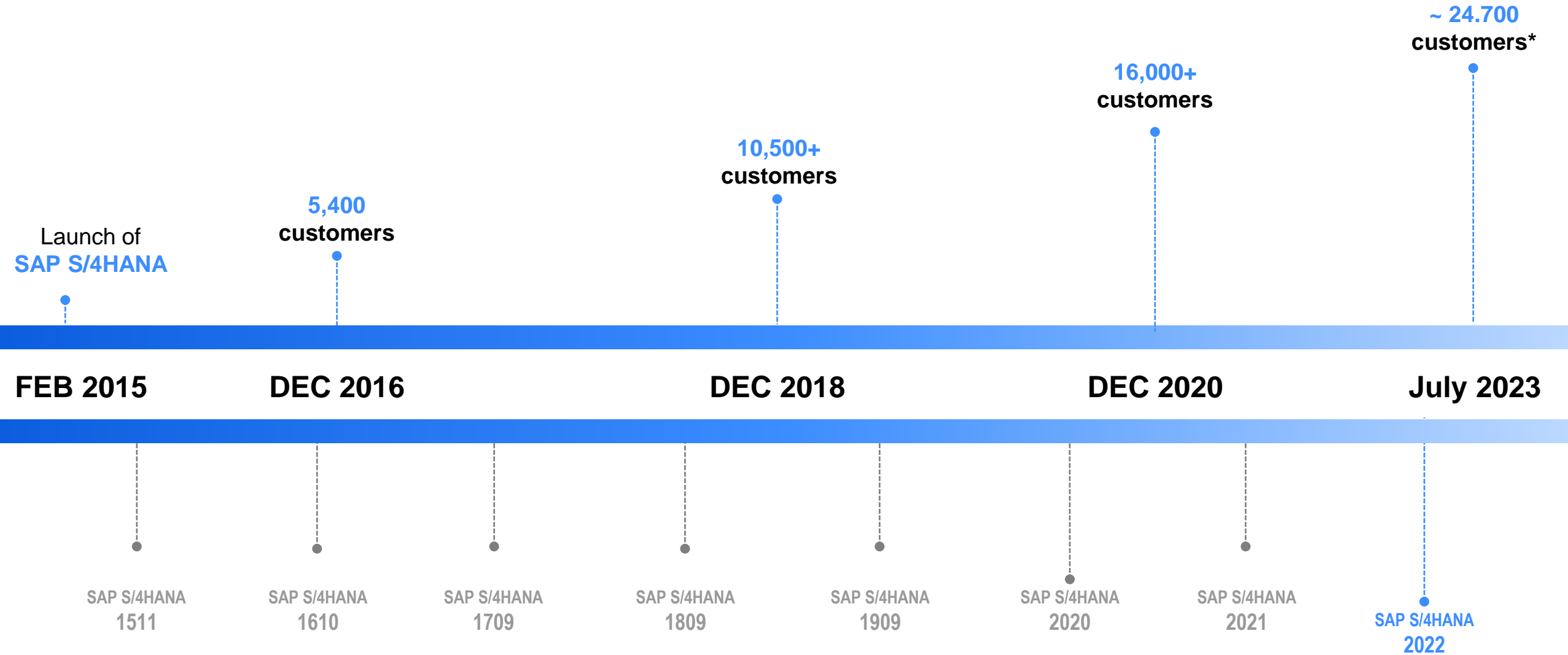

SAP S/4HANA Cloud, Private Edition, and SAP S/4HANA

Release strategy for 2023 → 2025 and definition of deliveries

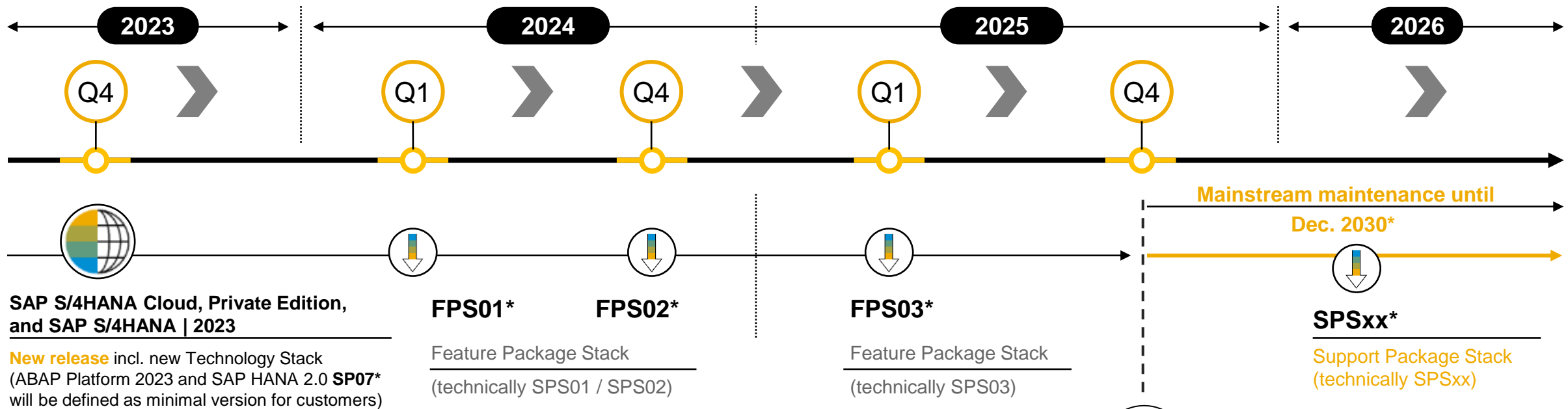

SAP S/4HANA Cloud, Private Edition, and SAP S/4HANA | 2023

New release incl. new Technology Stack (ABAP Platform 2023 and SAP HANA 2.0 **SP07*** will be defined as minimal version for customers)

FPS01*

Feature Package Stack (technically SPS01 / SPS02)

FPS02*

FPS03*

Feature Package Stack (technically SPS03)

SPSxx*

Support Package Stack (technically SPSxx)

Mainstream maintenance until

Dec. 2030*

Support Package Stack for SAP S/4HANA Cloud, Private Edition, and SAP S/4HANA *

After the general availability of SAP S/4HANA Cloud, Private Edition, and SAP S/4HANA, Feature Package Stacks (FPS) and Support Package Stacks (SPS) contain stabilizations bundled with corrections and legal changes. Customers benefit from this functionality as part of their maintenance fee. The first SPS of a new release can contain selected features and is labeled Feature Package Stack (FPS) accordingly. Support Package Stacks are compiled periodically and made available in the [SAP Service Marketplace](#)

SAP S/4HANA Cloud, Private Edition, and SAP S/4HANA | 2025*

New release incl. new technology stack

Important Links

[3348949 - Restriction Note](#)

[Restrictions and recommendations regarding specific revisions of the SAP HANA database for use in SAP S/4HANA](#)

[Release and maintenance strategy for SAP S/4HANA](#)

SAP S/4HANA Cloud, private edition 2023 and beyond

SAP S/4HANA

Planned Roadmap (subject to change)

2022	2023 (FPS0) 11.Oct.2023		2023 (FPS1) 28.Feb.2024	2023 (FPS2) Q4 / 2024	2023 (FPS3) Q1 / 2025	2025	... 2040	
Asset-centric Service	Enh. Maint. Sched. Board	Service with adv. Execution	Integration with MS Teams	Intelligent Goods Receipt	Intelligent Work Order	...	Enhanced Sustainability	tbd
Complex Services (Central Proc.)	Interaction Center (Utilities)	Carbon Footprint Data in Sourcing	Adv.Scheduling Board	Intelligent Dunning	Intelligent Back Order Process.	...	Enhanced Assets	tbd
Supply-based Confirmation	Advanced Intercompany Sales	Greenhouse Gas Emission	Predictive Liquidity Forecast	Batch Specific Unit of Measure	Green Ledger	...	Enh. Sales Order Scheduling	tbd
SAP S/4HANA Cloud, ABAP environment	Clean Core	RISE with SAP Premium Plus	'My Home' Fiori Entry Screen	Digital Assistant Joule	...	Central Business Configuration	tbd	

SAP S/4HANA Innovation Highlights 2023

2023

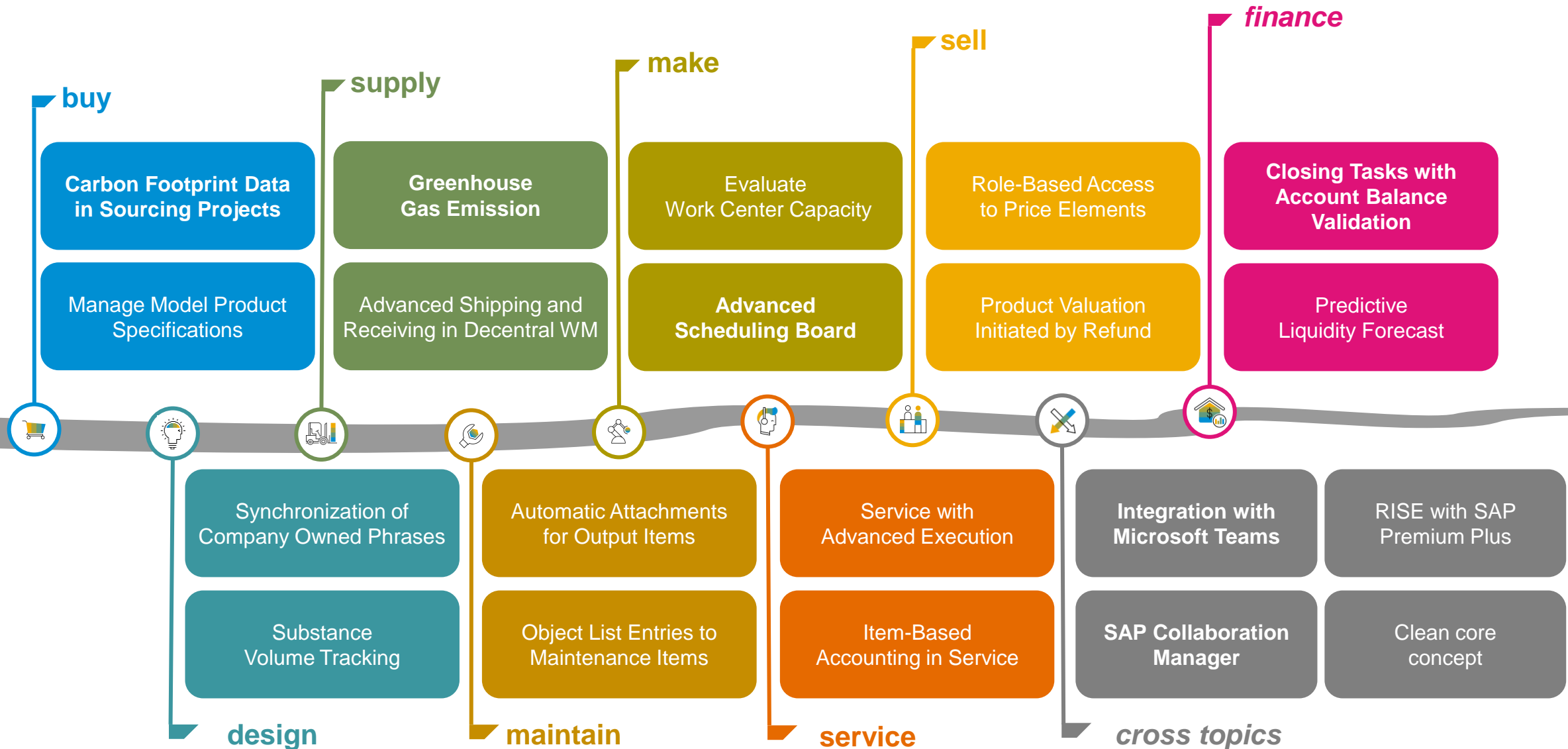

SAP S/4HANA Cloud, Private Edition | 2023 Release

Key Innovations in the 9th wave – Overview

Finance



- Organizational flexibility in financial accounting: profit center reorganization
- SAP S/4HANA Cloud for advanced financial closing, public edition
- SAP Fiori app for incoming payments – success rate
- Intraday bank statement handling
- Electronic document consistency check
- Use of Promise-to-Pay Documents as Payment Advice

PLM / EPPM



- Support for multiple occurrences of a change item in change records
- Advanced variant configuration – use of simulation to explode configurable iPPE structures
- EPPM:** New SAP Fiori app to schedule project forecasting jobs
- EPPM:** Reading project cash management data from universal journal
- EPPM:** Use of responsibility management teams to assign employees to network activities

Sourcing and Procurement



- Collecting and managing carbon footprint data from suppliers during direct material sourcing process
- Support for the factory calendar in supplier evaluations
- View analytical insights for sourcing projects and supplier quotations
- Initiate negotiation and awarding scenario creation directly from the quotation comparison application
- Mass management of sourcing-project line items using MS Excel

Sales / Subscription Billing



- Configure role-based access to price and cost details in sales documents and in billing process documents
- Flexible billing document posting – suppressing automatic posting
- Managing sales orders app, version 2 – support of an ATP result screen
- Suspending product valuation initiated by a refund in the returns process
- Integration of payment-by-link functionality in dunning correspondence

Product Compliance / EHS



- Ability to keep company-owned phrases synchronized
- Listed substance provisioning through a regulatory content service
- Multiple address handling, international address version support, and multi-name print support for safety data sheets
- Provision of greenhouse gas emissions data to support integration with SAP Sustainability Control Tower
- Single overview page with workplace safety insights

Supply Chain



- aATP:** Supply protection with the setting “restriction outside planned protection”
- eSPP:** Use gradient boosting of decision trees forecast with multiple external time series to enhance planning quality
- eSPP:** Flexible demand history adjustment

ePPDS



- Tank Planning: Adv. Scheduling Board, Tank Split, DS Opt.* (restrict.)
- Order Notes Management
- User Experience: Fiori Launch Pad, Fiori “Islands”, Adv. Sched. Board
- Flexible Constraints to consider target supply quantities (IBP Integration)

PEO



- Using production integration portal (PIP), migrate legacy external routings to shop floor routing
- Batch processing of multiple serial no. from multiple production orders
- Cross-domain collaboration between production engineers and shop-floor workers and supervisors
- Ability to identify maturity level of bill of material (BOM) using BOM status

Asset Management



- SAP Fiori app to manage serial numbers
- Standard user role for master data specialists
- Assignment of people to operations in the maintenance scheduling board
- New option to generate recurring schedules automatically
- Enhancements to Manage Maintenance Schedule for Assets: Multiselection, context menu, and quick assignment to events

Service



- Item-based Accounting for Service Transactions
- Additional features for integrated Service with Adv. Execution scenario
- Procurement of external services for service and repair orders
- Intercompany execution of service orders
- Ability to consume serialized parts through service / repair confirmations

Industry to Core



- Aerospace and Defense:** Pegging history analysis by time intervals and Fiori app for cost distribution
- Aerospace and Defense:** Costed stock gain by movement type and breakpoint upload through Excel
- Utilities:** Analysis and management of utilities clarification cases in business process exception management
- Public Sector:** New SAP Fiori app for maintenance of earmarked funds

Inventory Management



- Enabling bar code scanning in SAP Fiori apps for goods receipt
- Job scheduling for printing physical inventory documents using the Schedule Physical Inventory Jobs app
- Deletion of feature update to SAP Fiori app “Manage Physical Inventory Documents”
- Business event for the material document item

Extended Warehouse Management



- Customer influence topics for EWM – automatic packing, picking, and put away of multiple handling units at once and more
- Link between inspection lots and material documents for stock postings with usage decisions
- Warehouse API updates for products, orders, and tasks; handling units, delivery orders, and stock

Production Planning



- New SAP Fiori app for capacity evaluation
- MRP live: enablement of the simple distribution key
- New, modernized SAP Fiori app “Manage Material Coverage”
- Flexible definition of display horizons based on decoupled lead time in demand-driven replenishment apps
- Refinement of the average-daily-use (ADU) and classification calculations

Transportation Management



- Enabling normalized quantity in charge calculation & subcontracting
- Transportation unit-based integration of TM and EWM – enabling departure reversals
- New SAP Fiori app for making change requests to update freight order charges
- New shipping and receiving for side-by-side scenario

Cross-Topics



- Master Data Management:** Increased automation by leveraging external reference data to create and enrich business partner records
- Master Data Management:** Federation with SAP Master Data Governance as the core data owner for a business partner
- Business Data Validation:** Option to include custom reports for validation
- System Provisioning:** Support for Data Migration Option to SAP S/4HANA Cloud, private edition on Azure

SAP S/4HANA Cloud, Private Edition | 2023 Release

What's new in User Experience & Collaboration



Collaborate with your co-workers in Microsoft Teams

2023

Integration with
Microsoft Teams

The screenshot shows the SAP 'Manage Sales Orders - Version 2' interface. A 'Share to Microsoft Teams' dialog box is open, allowing the user to share the current view with a Teams chat. The dialog includes a 'Share to' dropdown menu with 'Sales Processing' selected, a text area for a message, and a 'Share' button. The background shows a list of sales orders with columns for Net Value, Document Date, and Delivery Block.

Net Value	Document...	Delivery Block
70.736,00 USD	02/25/2023	
70.736,00 USD	02/24/2023	
440.332,00 USD	02/24/2023	
700,17 USD	02/24/2023	
700,17 USD	02/24/2023	
220.608,00 USD	02/23/2023	
220.608,00 USD	02/23/2023	
149.872,00 USD	02/22/2023	

The screenshot shows the Microsoft Teams interface with the SAP 'Manage Sales Orders - Version 2' app embedded in a chat channel. The app displays the same sales order list as the previous screenshot, with columns for Sales Order, Sold-to Party, Customer Reference, and Requested Delivery Date. The Teams interface includes a search bar, a list of teams, and a 'Meet' button.

Sales Order	Sold-to Party	Customer Reference	Requested Delivery...
325604	SK Vision Corp-C (1000294)	20230225	02/28/2023
325603	SK Vision Corp-C (1000294)	20230224	02/27/2023
325602	SK Vision Corp-C (1000294)	20230224	02/27/2023
325601	Tech Bike Corp-W (1000292)	20230224	02/26/2023
325600	SK Vision Corp-C (1000294)	20230224	02/27/2023

Share **access to critical business**
issues with your co-workers **in chats***

Make critical business issues
part of your Teams channels*

SAP Collaboration Manager:

2023

SAP Collaboration
Manager

- Allows end users to
 - take notes
 - chat with other users
 - upload and share files
- Link your chat to any screen in your apps for reference
- Take screenshots to add directly to your chat without having to close SAP Collaboration Manager
- Annotate, highlight, and conceal areas of your screenshot
- Jump directly to the screen where a screenshot was created from
- See how many unread chats and chat items you have at one glance
- SAP Collaboration Manager is available for S/4HANA Cloud, private edition.
- Integrated in the SAP Fiori launchpad
- Prerequisites for usage is [setting up the Collaboration Manager](#) in the SAP Business Technology Platform and integration into SAP S/4HANA Cloud

The screenshot displays the SAP Collaboration Manager interface. At the top, there is a navigation bar with the SAP logo, a 'Home' dropdown, and a search bar. Below this is a secondary navigation bar with tabs for 'My Home', 'Purchasing', 'Sourcing and Contracting', 'Internal Sales', 'Billing', and 'Customer Returns'. The main content area is divided into several sections: 'To Dos (1)' with a task 'Approve Purchase Order 450000092' (Medium Priority, Created By: Example TesterSit, Task created 2 months ago); 'Pages' with five colored buttons for 'Overview Purchasing', 'Purchase Requisition Processing Purchasing', 'Purchase Order Processing Purchasing', 'Supplier Evaluation Purchasing', and 'Purchasing Rebates Purchasing'; 'Apps and Activities' with tabs for 'Favorites', 'Recent Activities', and 'Frequently Used', showing 'Manage Sales Orders Version 2' and 'My Sales Overview'; and 'Insights (8)' with four charts: 'Supplier Performance Monitoring Supplier Evaluation Trend' (Operational Score by Quarter), 'Supplier Performance Monitoring Supplier Performance Monitoring' (Operational Score and Purchasing S...), 'Purchasing Spend Purchasing Spend Trend' (PO Net Amount by Quarter), and 'Non-Managed Spend As % of total spend | By Material Group' (Not assigned 100%, 2.9K EUR). A chat window is overlaid on the right side, titled 'Help for PO Appro...', showing a conversation between 'internal_sales_rep example.com' and 'purchaser example.com'. The chat messages include: 'Hi Paul, here is your new colleague. Can you please let me know, if I can approve straight away?', 'Hi Isabel, for sure. Please go ahead!', and 'Excellent! Will do so. Thanks a lot for your help :-)'.

SAP S/4HANA Cloud, Private Edition | 2023 Release

**Selected highlights from Procurement, Sales,
Finance, Supply Chain & Manufacturing**



SAP S/4HANA Cloud, Private Edition | 2023 Release

What's new in Sourcing and Procurement

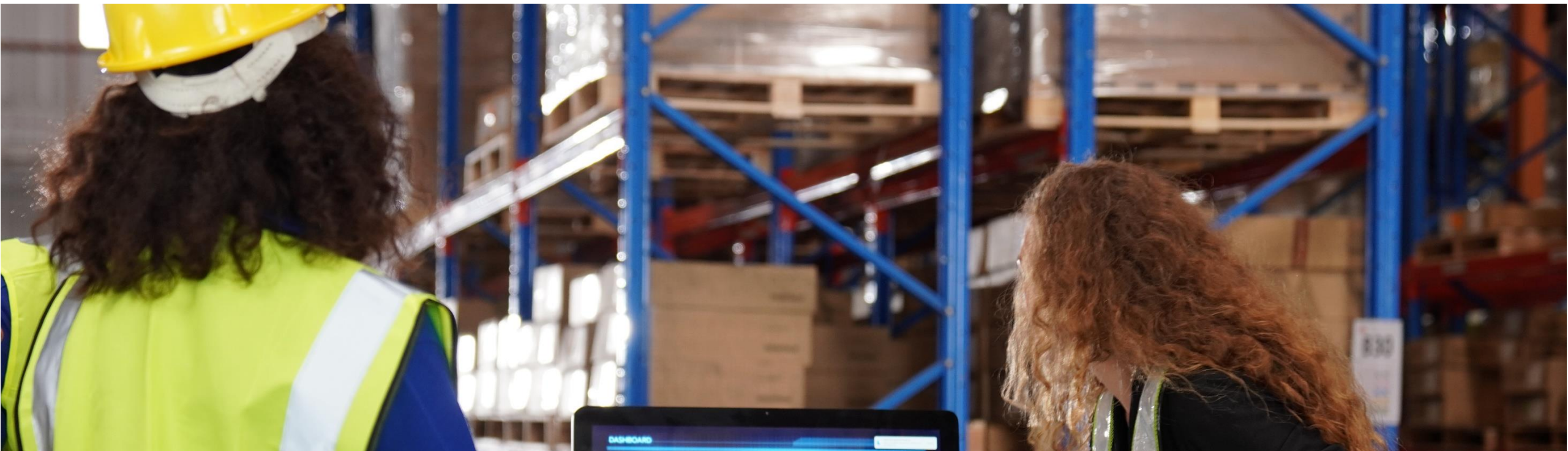

SAP S/4HANA Sourcing and Procurement: Delta Scope Summary

2023

Central Procurement

- **Material group recommendation** based on machine learning algorithm analyzing matching demands in previous backend purchase orders
- **Mass change** of standard fields in centrally managed purchase requisitions using a dedicated SAP Fiori app in **online** mode (not spreadsheet-based)
- Configure **inquiry steps** within the **approval workflow** for centrally managed purchase orders, sending a rework task to one or multiple identified central purchasers

Product Sourcing (extended)

- Collecting and managing **carbon footprint data** from suppliers
- Product sourcing **overview page**
- **Mass management** of sourcing-project line items using a standard Microsoft Excel template
- **Initiation of negotiations or awarding scenarios** directly from the quotation-comparison application
- **Situation-based notification** of submitted supplier quotations

Self-Service Requisitioning

- Integration of the **Storage Location** field into self-service purchase requisition and derivation of delivery address from it
- **Inbound interface for supplier confirmations** within a single, central system referencing purchase orders that reside in the connected systems
- **Extension** of the existing **Copy to Other Items action**: GL account, goods recipient, unloading point
- **Extension** of the **central purchase requisition replication** to the connected backend with: Goods / invoice receipt indicators, requestor / author of requisition, technical key of Web service

Supplier Evaluation

- Support for the **factory calendar in supplier evaluations** for accurate and comparable evaluation results

Service Purchasing and Recording / Purchase Contract Management

- **Mass creation/change of model product specifications** from spreadsheets, with up to five levels of item hierarchies, comprising products and/or services and free text.

SAP S/4HANA Sourcing and Procurement: 2023 Delta Scope Highlight

2023

Carbon Footprint Data
in Sourcing Projects

Product Sourcing

Collect and manage **carbon footprint data** from suppliers during direct material sourcing process

- Sourcing manager requests carbon footprint information for the items that are sourced through sourcing projects
- Suppliers provide carbon footprint information at the item level through their quotations
- Sourcing manager can compare carbon footprint information submitted by multiple suppliers to choose carbon conscious suppliers for award decisions

Benefits

- Ease collecting scope 3 emission information during the sourcing process directly from suppliers
- Increase visibility to carbon footprint information during the sourcing process to help organizations to choose carbon-conscious suppliers

The screenshot displays the SAP 'Compare Supplier Quotations' interface. It shows three supplier quotations for 'Model X_AC Assy' (10007649) with a total target amount of 950,000.00 EUR. The interface is organized into a grid of summary cards for each supplier, with a detailed 'Carbon Footprint Data Provided' table at the bottom.

Supplier Quotation	Total Amount	Carbon Footprint Data Provided
100 (20006270)	1,06M EUR	Quantity: 200,000 KG Share of Primary Emissions: 35 % Period Start Date: 15.06.2023 Period End Date: 30.06.2030 Boundary Condition: Cradle to Gate Country/Region of Supplier Plant: DE Region of Supplier Plant: BB Source of Emission Factor: Ecovadis Supplier Plant: SUP1 PLANT1
1000930 (20006271)	1,14M EUR	Quantity: 210,000 KG Share of Primary Emissions: 25 % Period Start Date: 15.06.2023 Period End Date: 09.06.2032 Boundary Condition: Cradle to Gate Country/Region of Supplier Plant: DE Region of Supplier Plant: BB Source of Emission Factor: Ecovadis Supplier Plant: SUP3 PLANT 1
1010 (20006257)	988,000.00 EUR	Quantity: 160,000 KG Share of Primary Emissions: 35 % Period Start Date: 15.06.2023 Period End Date: 26.06.2031 Boundary Condition: Cradle to Gate Country/Region of Supplier Plant: DE Region of Supplier Plant: BB Source of Emission Factor: Ecovadis Supplier Plant: SUP2 PLANT 1

Manage Sourcing Projects

SAP S/4HANA Cloud, Private Edition | 2023 Release

What's new in Sales and Subscription Billing



SAP S/4HANA Sales: Delta Scope Summary

2023

Order and Contract Management

Price Management

- Configure role-based access to price and cost details in sales documents and in billing process documents

Sales Order Management and Processing

- Managing sales orders app, version two – support of an available-to-promise (ATP) result screen

Sales Billing & Solution Billing

- Flexible billing document posting – suppressing automatic posting

Claims, Returns, and Refund Management

- Suspending product valuation initiated by a refund in the customer returns process
- Enhancements to the SAP Fiori app “Manage Customer Returns (Version 2)”: supporting attachments, process flows, and additional fields

Solution Business Management

Solution Quotation Management

- Support of multilevel configuration in solution quotation management

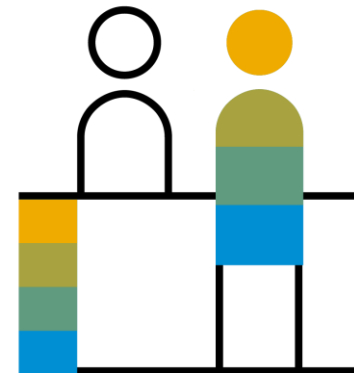

SAP S/4HANA Cloud, Private Edition | 2023 Release

Innovation Highlight – Subscription Billing and Revenue Management

Subscription Order Management



Support multilevel configuration in subscription order management

- Support multilevel configuration for Subscription Contracts
- Define and modify Multi-level characteristic values associated with the AVC items using UI
- Support variant prices on all levels

Benefit

Enable customers to have more flexibility and transparency using the following in subscription order management:

- Offer configurable Multilevel Products with increased efficiency and accuracy and predetermined rules
- Maintaining characteristics for BOM items during the configuration ensures accurate representation of the selected configuration in the subscription order
- Improve customer satisfaction with increased customization options

Component	Pos.	Cat.	Qty
Multi level Cloud Infrastructure	✓		1 EA
Workload - Bare Metal	✓ 0010 N		2 EA
Workload - Virtual Machine	✓ 0020 N		1 EA
VM Instance - General Purpos	✓ 0010 N		1 EA

Short Text	Actions	Selected	Item	Product	Quantity	Contract
Multi level Clo...			10	SOM_MSU_PVT_CLOUD_INFRA	1	
Subscription...			20	SOM_10F_ACTIVATION	1	
Workload - ...			30	SOM_SCR_WL_BARE_METAL	2	
Workload - ...			40	SOM_MSU_WL_VIRTUAL_MACHINE	1	
Cloud Subsc...			60	SOM_SCR_CLOUD_STORAGE	1	

Key innovations do not reflect licensing

SAP S/4HANA Cloud, Private Edition | 2023 Release

What's new in Finance

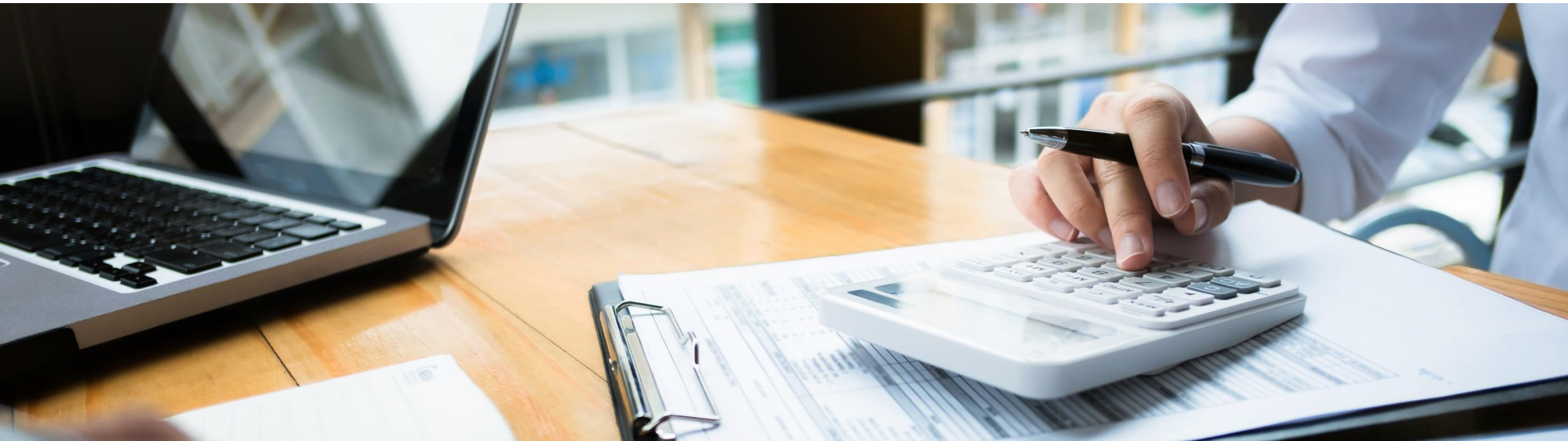

SAP S/4HANA Finance: Delta Highlight

2023



SAP Analytics Cloud (Planning)



- Improved integration scenarios with SAP S/4HANA including content for fast time-to-value & applied prediction and AI, including
 - Predictive liquidity forecast and intelligent cash collections
 - Financial planning content integration with sales planning
 - Planning consolidation

SAP Cloud for Advanced Financial Closing



- Automated balance validations for improved closing quality
- Advanced orchestration of SAP Intelligent RPA bots for closing for further automation scenarios

Advanced Accounting & Financial Close



- Group reporting** innovations include:
 - Flexibility in currency rates specific to a consolidation unit or date
 - Automation of Method Change and Goodwill Treatment in the consolidation of investments
- Central Finance** innovations include:
 - Improved error resolution in all pending journal entries
 - More flexible and enhanced cost object replication and currencies

Billing and Revenue Innovation Management



- Convergent Invoicing**
 - Subscription contract lifecycle management
- Subscription Order Management**
 - Extensibility driving transparency and flexibility for services and subscription

Advanced Treasury and Working Capital



- Improved In-house bank functionality
- Advanced bank statement handling for intra and end day statement
- Improved smart trading for hedge request
- Advanced memo record processing
- Intelligent Collections – predictive capabilities to help cash collections teams reduce late payments
- Promise-to-Pay Documents as Payment Advice
- Advanced Reprocessing rule definition for Open Item Clearing

Accounting and Financial Close

Organizational flexibility in financial accounting: profit center reorganization is available with new analytics and improved usability and is considered in key scenarios, such as for network and network activities, for maintenance orders, in predictive accounting, and in accruals management.

New user experience for journal entry management

Simplified definition and automated execution of account balance validations to ensure data quality

Cost Mgmt., Profitability & Margin Analysis

- Handle multiple accounting principles using ledgers in Management Accounting (Universal Parallel Accounting*)
- Group ledger to provide a management view of intercompany transactions
- Review Booklet for Margin Analysis for Sales Accountants

International Trade & Tax

- Automated checks to ensure consistency of electronic documents with authorities' portals
- Automated error notifications for e-docs failures
- Enhanced preview of statutory reports to enable simpler review of errors and faster corrections
- Suppression of purchase doc output in integration scenario with SAP GTS compliance service
- Enterprise search for trade compliance documents based on key attributes

SAP S/4HANA Cloud for Advanced Financial Closing

Entity Close Orchestration

2023

Closing Tasks with
Account Balance
Validation

Automated supervision of closing tasks with account balance validation

New SAP Fiori apps to maintain and execute financial closing validations such as balance verifications before and after closing tasks, detection of variances between current and previous periods and more. Define account balance validation rules.

- Execute validations and analyze results.
- Plan validations as part of entity close, and orchestrate the process based on results.

Benefit

- Improve entity closing process governance with full visibility of validations.
- Reduce manual effort and accelerate the closing by automating error detection and notifications.
- Higher financial statement quality via early data qualification.

The image displays two SAP Fiori app screenshots. The left screenshot, titled 'Define Validation Rules', shows the configuration for rule 'CJ0002'. It includes fields for 'Rule ID', 'Status', 'Created By', and 'Created At'. Below, there are sections for 'General Information', 'Rule Expression', and 'Operand Expression Editor'. The right screenshot, titled 'Validation Results', shows a 'Failed' result for rule 'CJ0003'. It features a table with columns for 'Currency Code', 'Account class', 'Amount', 'Left-side Value', 'Right-side Value', and 'Difference'. The table lists various account classes and their corresponding values and differences.

SAP Fiori app "Manage Balance Validation Rules and Groups": App ID F6386

SAP Fiori app "View Balance Validation Results": App ID F6387

SAP S/4HANA Cloud for Advanced Financial Closing

Entity Close Orchestration

Automated execution of closing tasks with SAP Build Process Automation

SAP S/4HANA Cloud for Advanced Financial Closing can now automate execution of closing tasks leveraging SAP Build Process Automation, provide full visibility of completion status and trigger notifications to prompt actions if any failure occurs. Some examples can be reconciliations between systems for distributed landscapes, import of data from other systems, etc.

- Trigger execution of automated processes through an ABAP program in the communication system.
- Automate status update after execution.

Benefit

- Add intelligence and automation by using SAP Build Process Automation for high-frequency and high-volume manual closing tasks.
- Reduce manual efforts and the risk of errors for recurring activities.
- Accelerate closing cycles by flexibly leveraging SAP Build Process Automation.

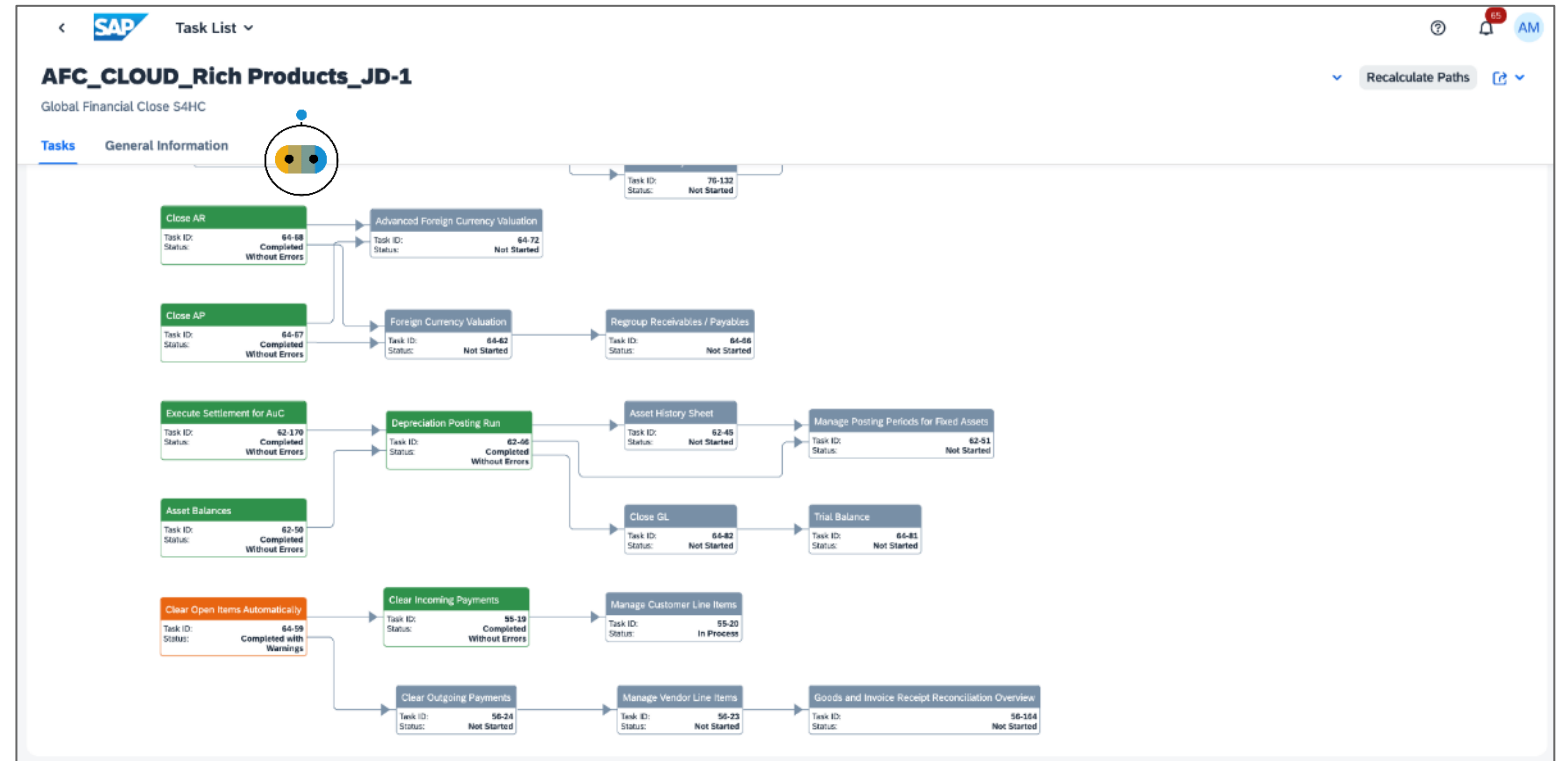

[SAP Build Process Automation Content Catalogue.](#)

SAP S/4HANA Cloud, Private Edition | 2023 Release

What's new in Manufacturing

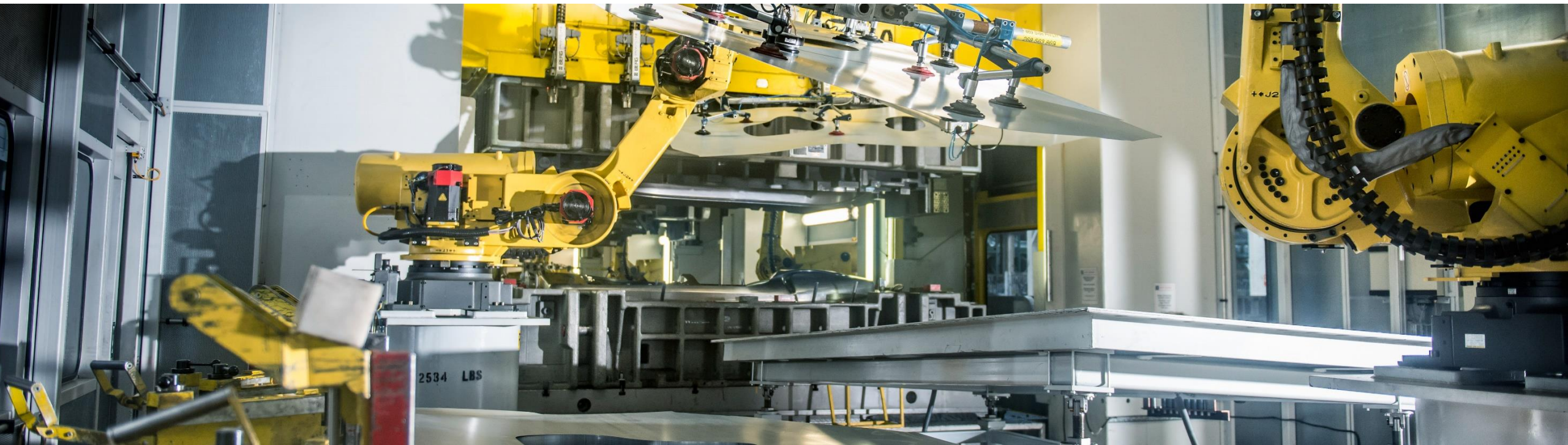

SAP S/4HANA Manufacturing: Delta Scope Summary 2023

2023



Ext. Production Engineering

- **Production integration portal (PIP)**
migrate legacy external routings to shop floor routing
- **Integration** of external PLM systems
- Identification of reference-only comp. in a BOM

Ext. Production Planning

- **Notes Management**
 - Collaboration and handover between planning and shop floor
 - Integrated with PP/DS order and PP production order long text
- **Tank Planning** for process industries: Manage Tank as storage resource
Filling and Draining multiple Storage Tanks with one Order (aka. 'Tank Split')
- **Constraint-based production planning**
More efficient scheduling with the new advanced **graphical scheduling board**

Production Engineering

- **Process Production Versions:**
Network Graph View for Master Recipe. Navigate in the Process Production Versions app to a network graph that represents the sequence of operations and phase relationship for master recipe.
- **Work Center Groups:**
New app features the column Work Center Group Type and also supports navigation to the Manage Work Center Groups
- **Work Center Responsibility**
New app defines the area of responsibility by selecting the respective combinations of plant and work center person responsible.
(incl. mass maintenance capabilities)

Production Planning

- **Manage Material Coverage::**
New, modernized SAP Fiori app Coverage
- **Capacity evaluation**
New SAP Fiori (Graphical Planning Board)
- **MRP live:**
enablement of the simple distribution key
- **MRP: Time-dependent Stock levels:**
 - Validity intervals for multiple materials
 - Upload intervals from spreadsheet
 - Visualization of relevant stock level values
- **Demand Driven MRP:**
 - Flexible definition of display horizons based on decoupled lead time
 - Refinement of the average-daily-use (ADU) and classification calculations

Production Operations / Options

- **Serialization:**
Batch processing of multiple serial numbers from multiple production orders
- **Internal Collaboration:**
Cross-domain collaboration between
 - production engineers
 - production supervisors
 - shop-floor workforce
- **Production Supervisor Responsibility**
New app to define your area of responsibility by selecting the respective combinations of plant and production supervisor. In the Manage Production Orders, Manage Production Operations, Manage Process Orders, and Manage Process Order Operations apps, only those orders or operations are displayed in the worklist that fulfill your selection criteria.

Quality Management

- **Quality Planning and Improvement**
Failure Mode Effect Analysis (FMEA) for products and processes with graphical UI to support quality by design
- **Quality Inspection**
Enablement of usage decisions for inspection lots with serialized materials
- **Quality Improvement**
Defect recording with defect code determination based on business rules (BRFplus). Warehouse defect with follow-up actions integrated with decentral EWM
- **SAP Quality Issue Resolution**
Supporting collaborative problem-solving processes (8D) with BTP App integrated with SAP S/4HANA QM (Q-notifications)

SAP S/4HANA Manufacturing: Advanced Scheduling Board (PPDS)

2023

Executive Summary

- 1) New interactive Gantt chart with flexible evaluation of planning horizon
- 2) Reschedule and realign interactively
- 3) Area of responsibility extended by work center groups

The screenshot displays the SAP S/4HANA Advanced Scheduling Board (PPDS) interface. The top navigation bar includes the SAP logo, 'Advanced Scheduling Board', a search bar, and user 'CH'. The main area is titled 'CHPP NEW' and shows a display horizon from 01.09.2023 to 30.09.2023. The Gantt chart displays resources like 'Final assembly 2' and 'Production 2' with various orders and alerts. The product stock visualization shows raw materials 'CHPP1RAW1' and 'CHPP1RAW2' with their stock levels over time. On the right, there are panels for 'Order in Past Alerts (13)' and 'Order Alerts - Product-Dependent (2)'.

Advanced Scheduling Board

SAP S/4HANA Cloud, Private Edition | 2023 Release

What's new in Supply Chain



SAP S/4HANA Supply Chain: Delta Scope Summary

Advanced Order Promising

- **Enhanced supply protection** with the newer option for restricting demands dependent on the remaining protection
- **New configuration for scope of check** (transaction OVZ9A) allows a more fine-granular definition which kind of stock-, supply- or demand-elements should be considered in the product availability check
- Enabling **Business Process Scheduling (BPS)** for **Stock Transport Orders** through configuration of activity attributes based on stock transport catalog

Inventory

- Enhanced **barcode scanning** including support for the composite barcodes based on international GS1 standard various SAP Fiori apps for to process of inventory adjustments
- **Inventory Analytics** and **Control** enhancements including consignment stock reporting and automating email notification to suppliers
- **Extensibility enhancements** to various inventory management related business objects

Advanced Warehousing

- **Support for Advanced Shipping and Receiving (ASR) in decentral warehouses** - integration of advanced shipping and receiving processes in decentralized deployment
- Introduction of a **simplified Kanban** framework without deliveries for **decentralized extended warehouse management** in SAP S/4HANA
- Support **repetitive manufacturing** in **decentralized SAP EWM** with asynchronous confirmations, goods receipt- and goods issue postings

Warehousing

- **Automatic** packing, picking, and put away of **multiple handling** units
- Enable **Record Warehouse Defect** app in **decentral EWM** on S/4HANA
- **Handle defects / defective parts** in **decentral EWM** managed warehouses or PSAs

Advanced Transportation

- **Greenhouse gas emission calculation** for road freight including the **comparison** between planned and reported emissions
- **Support for Advanced Shipping and Receiving** in **decentral warehouse** with local Transportation management capabilities
- **Enhancements for package building** including support for cylindrical product shapes in package building optimizers
- **Enable normalized quantity** in charge calculation and subcontracting

Delivery and Transportation

- **Manage Incoterm Location** as Transportation Management (**TM**) Location and enable better integration with SD, MM, and LE in the context of incoterms

SAP S/4HANA Transportation Management

Greenhouse gas emissions

2023

Greenhouse Gas Emission

Advanced Transportation



Advanced Transportation Management

- Enhanced support for sustainability through enabling of greenhouse gas calculations
- Emission parameters can be set based on vehicle types
- Emissions for road freight orders are calculated during manual planning and automated vehicle scheduling and resourcing.
- Intuitive reporting through freight orders and cockpit

SAP Edit Freight Order with Subcontracting 6100160750

[Edit](#) [Refresh](#) [Copy](#) [Other Copy Options](#) [Check](#) [Follow Up](#) [Scheduling](#) [Subcontracting](#) [Create Service Order](#) [Schedule](#) [Set Status](#) [Load/Unload Plan Status \(Stop\)](#) [Execution Status](#) [Fixing](#) [Customs](#) [Charges/Settlement](#)

Emission

Calculated Emission: 371.265 KG
Emission Allocation Method: Distance Weight based Calculation

Reported Emission: 535.5 KG [Report Emission](#)

Stages

Standard * | [Insert](#) | [Merge](#) | [Execution Status \(Source\)](#) | [Execution Status \(Destination\)](#) | [Determine Distance and Duration](#)

Stage	Source Location	Source Loc... Address	Destination A... Location V...	Destination ... Address	I... Handli... A... Execut... V... Status	Distance	Distance Unit of Measure	Net Duration	Depart... Fixed	Planned Departure Date	Planned Depart... Time	Planned Depart... Time Z...	Actual Departure Date	Actual Depart... Time	Actual Depart... Time Z...	Planned Arrival Date	Planned Arrival Time	Planned Arrival Time Z...	Actual Arrival Date	Actual Arrival Time	Actual Arrival Time Z...	Maximu Utilizati...
<input type="checkbox"/> 1	PW_A		PW_B		♦	21.999 KM		0:16	N...	00:00...	CET		00:00...	CET		00:00...	CET		00:00...	CET		
<input type="checkbox"/> 2	PW_B		PW_C		♦	8.486 KM		0:06	N...	00:00...	CET		00:00...	CET		00:00...	CET		00:00...	CET		
<input type="checkbox"/> 3	PW_C		PW_D		♦	7.186 KM		0:05	N...	00:00...	CET		00:00...	CET		00:00...	CET		00:00...	CET		

[General Data](#) [Business Partner](#) [Items](#) [Utilization](#) [Subcontracting](#) [Document Flow](#) [Charges](#) [Notes](#) [Attachments](#) [Statuses](#) [Blocking Information](#) [Administrative Data](#) [Terms and Conditions](#) [Output Management](#)

[Execution](#)
[Overview](#)
[Document References](#)

[Save](#) [Cancel](#)

SAP S/4HANA Cloud, Private Edition | 2023 Release

Where to go for more information



SAP S/4HANA Cloud, Private Edition | 2023 Release

Innovations in the 9th wave

Home › Community › Blogs

Ask a Question Write a Blog Post [Login / Sign-up](#)

Product Information

 **Bert Schulze** [SAP](#)
October 11, 2023 | 16 minute read

SAP S/4HANA Cloud, Private Edition 2023 Product Launch

2 14 3,887

[Follow](#)

[Like](#)

[RSS Feed](#)

I am excited to share that the 2023 release of SAP S/4HANA Cloud, private edition is here – the most intelligent and comprehensive cloud ERP to date. I have the pleasure to walk you through the key aspects that bring intelligence to our digital core along with some of the highlights of the release.

Recently, we have talked a lot about innovation shipment in the cloud. This means:

A) The private cloud is here to stay, and you benefit from broad investments.

B) It is the major product for customers who prefer to do a conversion into the cloud. **SAP S/4HANA Cloud, private edition** offers you 3 main routes to get into.

- A green field fresh start.
- A partial conversion.
- And a brown field conversion from your current ERP base.

And of course, it offers you an upgrade if you are already on SAP S/4HANA Cloud, private edition.

C) Whatever you decide to do: Keep our clean core strategy in mind.

Our new release and maintenance strategy for SAP S/4HANA Cloud, private edition was communicated recently. This includes a new planning of feature pack stacks over longer cycles. This means customers have much better possibility and flexibility to always stay current, and more time to adopt new innovation. The major releases are coming in 2-year cycles.

Now, let's have a look at the new 2023 release and what it contains.

To get an overview of my personal highlights, you are welcome to share a few minutes with me and watch my highlight video below.



SAP S/4HANA Cloud, Private Edition 2023 | Pr...

SAP S/4HANA Cloud, Private Edition 2023 Product Launch

[Watch Now!](#)

Ansehen auf [YouTube](#)

Assigned Tags

SAP S/4HANA Cloud
Artificial Intelligence
Cloud
SAP ERP
SAP S/4HANA Cloud, private edition
PSCC_Enablement

Similar Blog Posts

ABAP Cloud
By Boris Gebhardt Dec 22, 2022

Link Collection - Governance, Risk and Compliance (GRC) with SAP S/4HANA and SAP S/4HANA Cloud
By Katrin Deissner May 08, 2020

Sales in SAP S/4HANA Cloud – The Link Collection
By Christian Vogler May 11, 2020

Related Questions

Difference between S/4HANA Cloud (aka Essentials edition) and RISE with SAP S/4 HANA Cloud
By Suma Rammohan Aug 22, 2022

Why is the S/4HANA On-Prem and S/4HANA Cloud Extended release strategy for S/4HANA?
By Adil Zafar Sep 30, 2020

S/4HANA Cloud - Rise / Private Edition Customer Management
By Hayati Kayaci Aug 12, 2021

 [Product Launch Blog here](#)

Home › Community › Blogs

Ask a Question Write a Blog Post [Login / Sign-up](#)

Product Information

 **Christian Vogler** [SAP](#)
October 11, 2023 | 1 minute read

SAP S/4HANA Cloud, private edition | 2023 Release

0 2 640 Edit

[Follow](#)

[Like](#)

[RSS Feed](#)

With this 2023 release for SAP S/4HANA Cloud, private edition, we launch the next generation of business processes. This refers to intelligent and automated business operations that leverage the power of technologies like artificial intelligence (AI), machine learning (ML), advanced analytics, data processing capabilities, and the Internet of Things (IoT).

This new 2023 release of SAP S/4HANA Cloud, private edition brings innovations to all Lines of Business and Industries.

In this blog post, you will find the latest collection of new capabilities for this 2023 release. These blog posts will be published gradually over the coming weeks. Stay tuned!

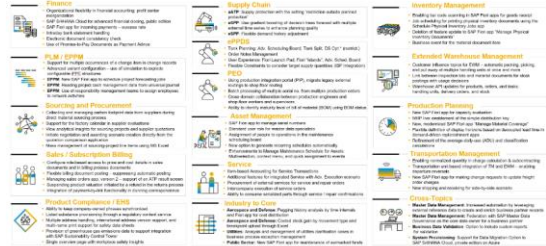

Procurement
Procurement flexibility to increase efficiency and reduce costs
Supplier selection based on extended financial rating, credit ratings, and ESG factors
AI-based recommendations for supplier selection
AI-based recommendations for contract management
AI-based recommendations for contract renewal

Supply Chain
SAP Supply Chain Control Tower (SCT) for end-to-end supply chain visibility
AI-based recommendations for supplier selection
AI-based recommendations for contract management
AI-based recommendations for contract renewal

Inventory Management
AI-based recommendations for inventory optimization
AI-based recommendations for inventory allocation
AI-based recommendations for inventory replenishment

Production Planning
AI-based recommendations for production planning
AI-based recommendations for production scheduling
AI-based recommendations for production control

Customer Service
AI-based recommendations for customer service
AI-based recommendations for customer support
AI-based recommendations for customer engagement

Assigned Tags

SAP S/4HANA Cloud, public edition
2023 Release
artificial intelligence
cloud erp
digital transformation
PSCC_Enablement
sap erp

Similar Blog Posts

Usage of ABAP Test Cockpit in the SAP S/4HANA Cloud, public edition
By Olga Dolinskaja Jul 19, 2023

News from SAP Activate – SAP S/4HANA Cloud, public edition 2308
By Jan Musil Jul 26, 2023

Successful SAP S/4HANA Cloud, public edition, implementations and ongoing operations – My experiences as head of Product Success Cloud Co-Innovation Team in the Americas and Greater China
By Marco Valencia Feb 28, 2023

Related Questions

Enhancement in Public Cloud
By Vivek Sharma Sep 01, 2023

Public Cloud vs Private Cloud?
By ghazwan abulghani Oct 10, 2023

SAP EAM product solution for S/4HANA Cloud, Public
By Mohammadamin Sepehri Aug 21, 2023

 [Collection Blogs here](#)

SAP S/4HANA 2023 Delta Highlights Video

[SAP S/4HANA Cloud, Private Edition 2023: Highlights in Seconds](#)





Influence our roadmap and feel free to ask your questions here:

[SAP S/4HANA Cloud, Private Edition – Community](#)

The screenshot shows the SAP Community website for SAP S/4HANA Cloud, Private Edition. The navigation bar includes 'SAP | Community', 'Products', 'Groups', 'Partner Groups', 'Events', 'Help', a notification bell with '44', an email icon, and a user profile icon. The breadcrumb trail is 'SAP Community Groups > Partner Groups > ERP and Finance > SAP S/4HANA Cloud, private edition >'. The main header features the title 'SAP S/4HANA Cloud, private edition' and a search bar with 'This group' and 'Search all content'. A banner below the header reads 'A New Home for SAP Community' with the text 'the perfect single location for everything our community has to — and wants to! — offer, especially as we continue to grow our community...'. Below the banner is a yellow callout box with the text 'A New Home in the New Year for SAP Community!' and 'Exciting times ahead for the SAP Community! We've outgrown our home, so we'll be migrating to a new platform later this year. Let's continue the journey together! Read all about the SAP Community Migration'. The main content area displays two posts. The first post, titled 'Welcome to SAP S/4HANA Cloud, private edition community. Get Started Now', has 1153 views, 4 comments, 27 likes, and is dated 03-10-2023. The second post, titled 'SAP S/4HANA Cloud, private edition Knowledge Center', has 2509 views, 1 comment, 15 likes, and is dated 03-07-2023. An 'Options' menu is visible on the right side of the post area.

Official SAP Road Maps webpage: sap.com/roadmaps

To view all SAP Road Map documents, visit www.sap.com/products/roadmaps/finder-all.html

SAP ROAD MAPS describe recent and upcoming highlights in SAP's portfolio to help you plan and implement your IT landscape.

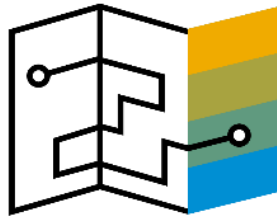

INTERACTIVE ROAD MAPS PLATFORM

SAP INTERACTIVE ROAD MAPS connect thought leadership with solution capabilities, business value, and innovations. This digital platform is the future of Road Maps, with more content being added regularly.

<https://roadmaps.sap.com>

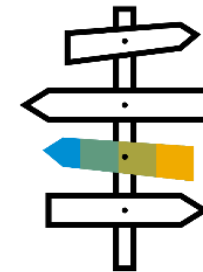

CUSTOM ROADMAPPING TOOL

SAP TRANSFORMATION NAVIGATOR brings together industry trends with the customer's business and IT priorities to create a custom road map to SAP S/4HANA.

<https://support.sap.com/stn>

SAP Roadmap Explorer

VIEW CURRENT INFORMATION IN ROAD MAP EXPLORER

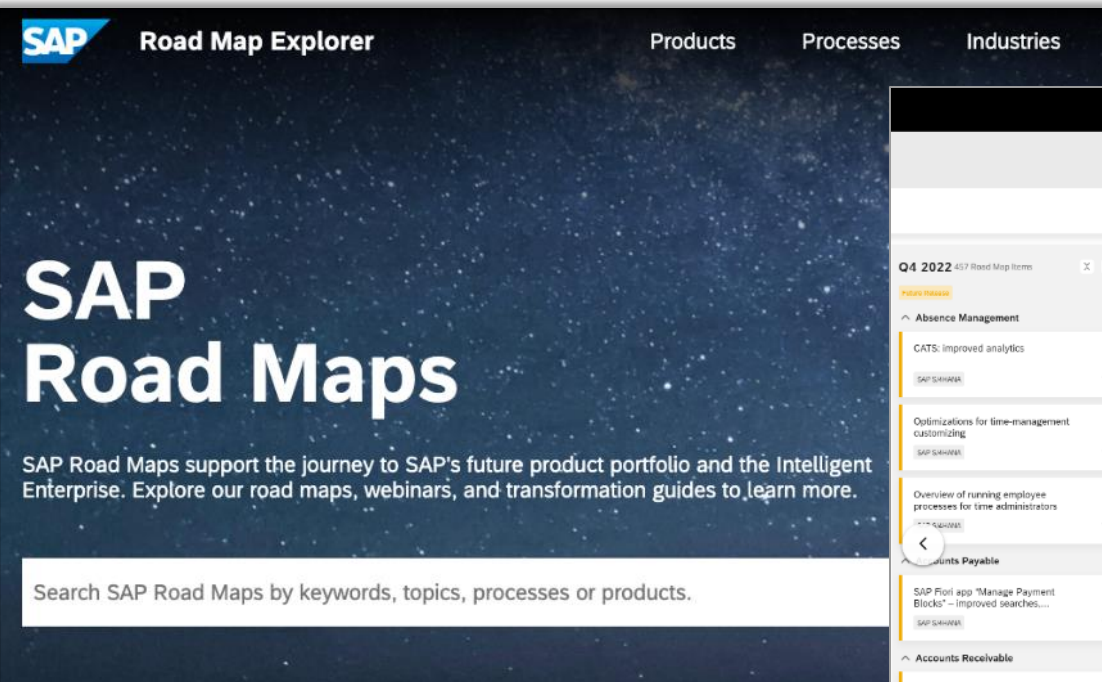

SAP Road Map Explorer

Products Processes Industries

SAP Road Maps

SAP Road Maps support the journey to SAP's future product portfolio and the Intelligent Enterprise. Explore our road maps, webinars, and transformation guides to learn more.

Search SAP Road Maps by keywords, topics, processes or products.

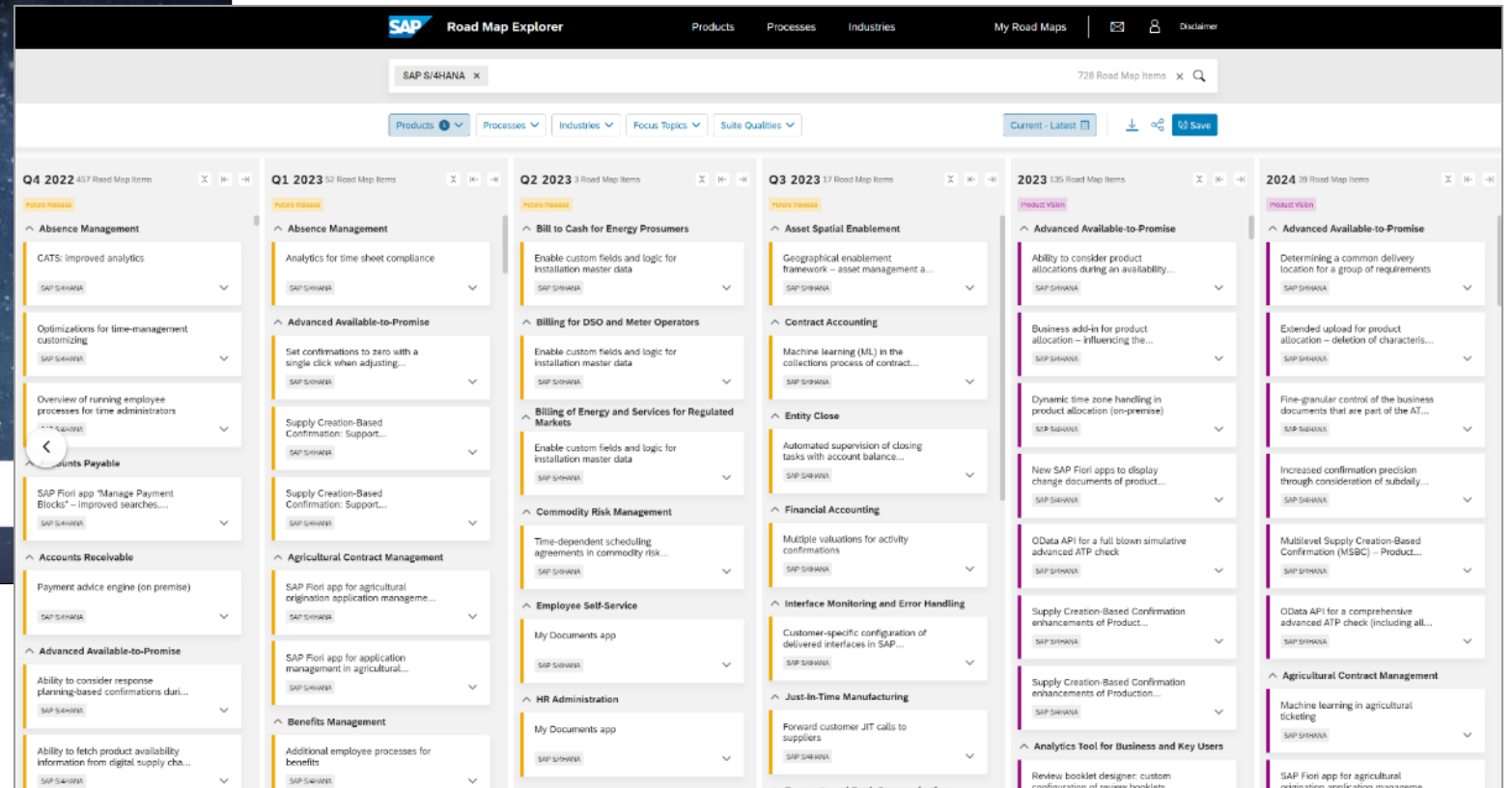

SAP Road Map Explorer

Products Processes Industries My Road Maps

SAP S/4HANA x 728 Road Map Items x

Products Processes Industries Focus Topics Suite Qualities

Current - Latest Save

Q4 2022 457 Road Map Items	Q1 2023 52 Road Map Items	Q2 2023 3 Road Map Items	Q3 2023 17 Road Map Items	2023 135 Road Map Items	2024 39 Road Map Items
Absence Management CATS: improved analytics Optimizations for time-management customizing Overview of running employee processes for time administrators	Absence Management Analytics for time sheet compliance Advanced Available-to-Promise Set confirmations to zero with a single click when adjusting... Supply Creation-Based Confirmation: Support...	Bill to Cash for Energy Prosumers Enable custom fields and logic for installation master data Billing for DSO and Meter Operators Enable custom fields and logic for installation master data Billing of Energy and Services for Regulated Markets Enable custom fields and logic for installation master data Commodity Risk Management Time-dependent scheduling agreements in commodity risk...	Asset Spatial Enablement Geographical enablement framework – asset management a... Contract Accounting Machine learning (ML) in the collections process of contract... Entity Close Automated supervision of closing tasks with account balance...	Advanced Available-to-Promise Ability to consider product allocations during an availability... Business add-in for product allocation – influencing the... Dynamic time zone handling in product allocation (on-premise) New SAP Fiori apps to display change documents of product...	Advanced Available-to-Promise Determining a common delivery allocation – deletion of characteris... Extended upload for product allocation – deletion of characteris... Fine-granular control of the business documents that are part of the AT... Increased confirmation precision through consideration of subdail...

For more information, click [here](#)

Thank you.

Contact information:

Zach Vernon
zach.vernon@sap.com

