

# Actionable Insights to Speed S/4HANA Modern Migration

*Ty Henson | 2024*

Director Solution Architects

**WORKSOFT**<sup>®</sup>

# What We'll Cover...

- Modern Challenges with S/4 Migration
- Identifying S/4 Migration Approaches
- Customer Story 1: Accelerating Your Understanding of Process
- Customer Story 2: The Truth about Reducing Defects and Maximizing Coverage
- Customer Story 3: Don't Wait for S/4 to Start Automating
- Customer Story 4: Automation Speeds Implementation

# BREAKING NEWS

*Stories at 11...*

**WORKSOFT**<sup>®</sup>

The resident  
knowledge of our  
People is a key

Proper automation  
provides Speed,  
Coverage, Defects

The time is now -  
Don't wait!

Applying these  
things can  
absolutely  
accelerate your  
project

# Modern Challenges with S/4 Migration



**WORKSOFT**<sup>®</sup>



# UNDERSTANDING BUSINESS PROCESS



Complexity across the typical large enterprise

## MULTI-VARIANT

Great employees find great answers!

## CROSS TECHNOLOGY

Multiple apps supporting customers and employees

## CROSS ACTOR

No one works in a silo!

## INSTITUTIONAL KNOWLEDGE

Best practices... not always documented!

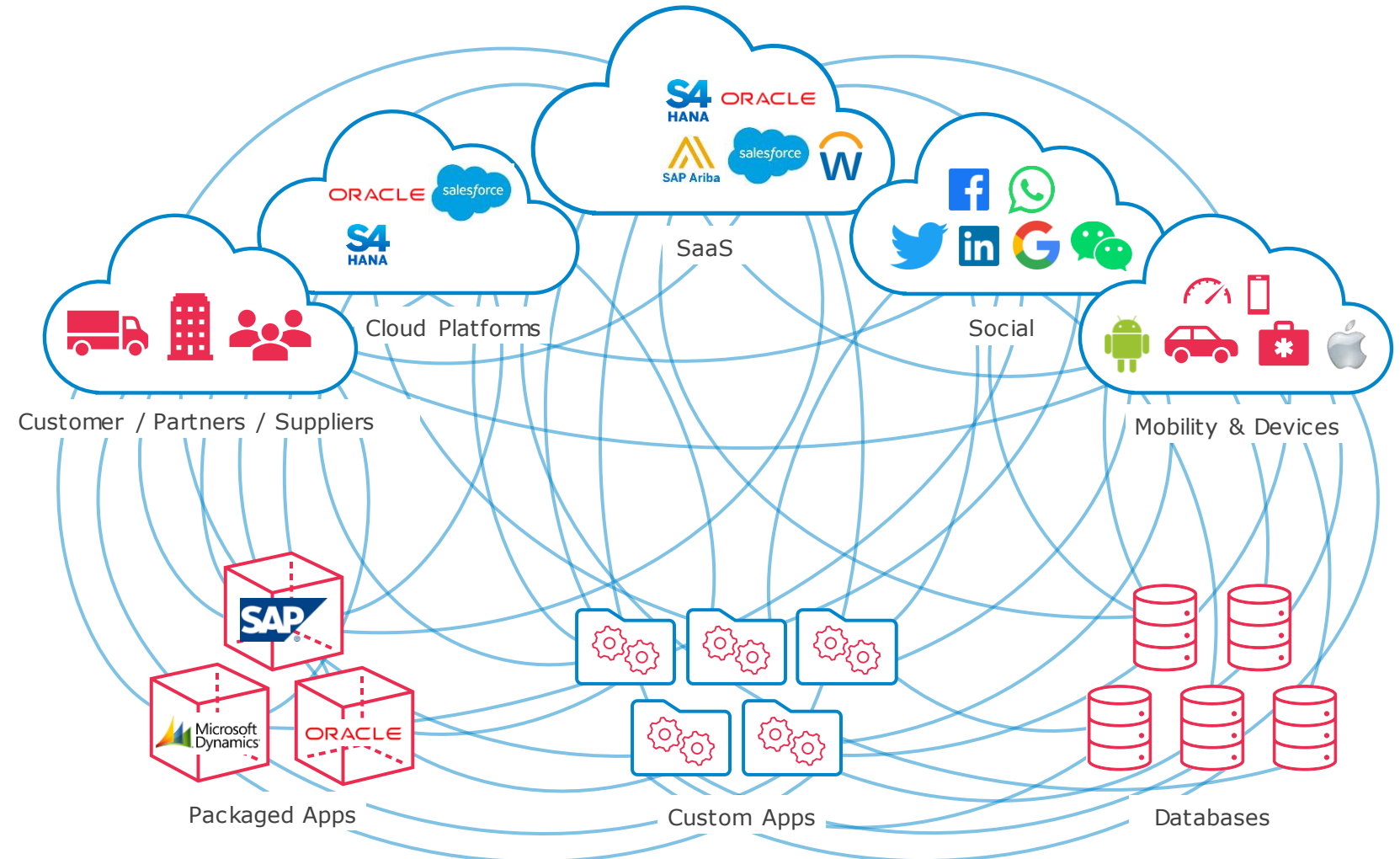

# Quantifying the Challenge

87%

Say the most important requirement as they migrate to SAP S/4HANA is...

**minimal disruption to operations**

Source: SAP Insider SAP S/4HANA Migration 2021 Benchmark Report

63%

Report that automation provides **cost savings**

Source: ASUG Insight Spotlight Survey 2021

39%

of SAP S/4HANA customers **underestimated the complexity** of their migration

Source: ASUG Whitepaper, "Expedite SAP S/4HANA Migrations and Maintain Business Continuity with Automation."

# Identifying S4 Migration Approaches



**WORKSOFT**<sup>®</sup>

# Approach to S/4 Migration

*No matter the approach or stage in your S/4 Journey, **automation is essential***

## BROWNFIELD/ HYBRID

Automate now,  
reuse later

Capture, document, &  
automate testing in ECC  
SAP GUI and E2E apps

Reuse ECC GUI automation  
in S/4HANA to test  
S/4HANA business process  
readiness.

## GREENFIELD

Start with a new and  
clean slate

Capture, document &  
automate testing in E2E  
apps

Build understanding of  
apps and processes that  
will interface with S/4HANA

*"End-to-end automation has allowed us to **gain efficiency and uncover defects we wouldn't have normally seen manually.** We use automation to validate data loads and identify data defects early, and we've automated close to 100% of our regression testing to build a foundation for the future."*

-Sachin Chhabra, IT Director,  
PepsiCo



# Accelerating Your Understanding of Process

*Heather Whitfield*

*Head of Process and Test Automation*

*Applied Materials*

# Applied Materials

*Worlds #1 semiconductor and display equipment company, Est. 1967*

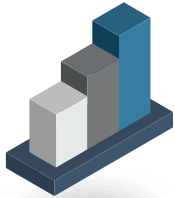

**\$23.06 billion** in revenue  
(TOTAL in 2021)



**~15,700** patents



**~27,000** employees  
in **19** countries

**WORKSOFT**



The last 15 years I've spent building the automation program...**number 1 challenge...the business really does not understand their processes completely. They think they do, but they really don't and if we can't get that process knowledge how are we going to move to S/4. It's a huge barrier.**



**Heather Whitfield**

Head of Process and Test Automation



So what we're doing. **We've started by focusing on the people first.** Looking at the process knowledge we have within our business. **Not just relying on the functional resources that we think has a lot of this knowledge, but actually looking into the business itself...to try to take this inventory of what process knowledge is out there...who we need to become part of the program. Who do we really need to bring in? And then looking to see where we have gaps.**



# SAP Easy Access

Other menu Create role More  🔍 🔍 🖨️ Exit

- 📁 Favorites
- ▼ 📁 SAP Menu
  - > 📁 Connector for Multi-Bank Connectivity
  - > 📁 Office
  - > 📁 Cross-Application Components
  - > 📁 Logistics
  - > 📁 Accounting
  - > 📁 Human Resources
  - > 📁 Patient Accounting
  - > 📁 Information Systems
  - > 📁 Customer Management
  - > 📁 Tools
  - > 📁 WebClient UI Framework

Untitled Capture

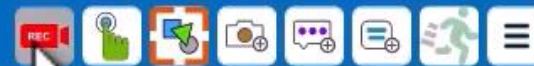

Start or Stop Capture

## Activity/Step

🕒 ⓘ Capture Reset 📄 📄

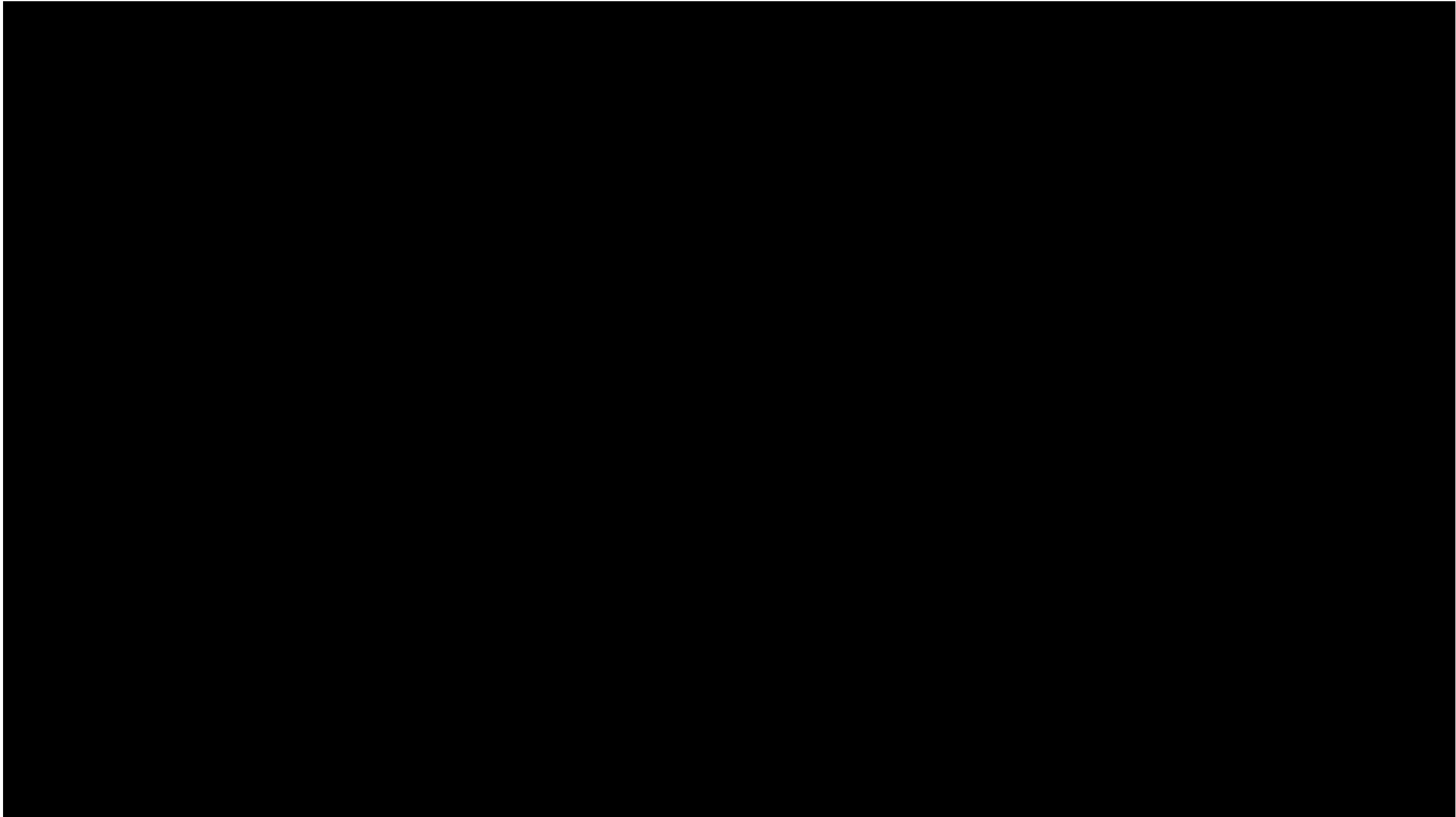

*PROCESS CAPTURE - FIORI*







## BestRun Process Documentation

### Business Process Documentation

**Document Name:** Simple Order  
**User:** thenson@worksoft.com

**Date Generated:** 07/12/2021 18:59:21 (UTC)  
**Document Name:** 07/12/2021 18:53:41 through:  
07/12/2021 18:56:47

**Document Description:** Name Activity

### Document Business Process

**Activity Flow:** Home --- Create Sales Documents --- Create Standard Order: Overview --- VL01N

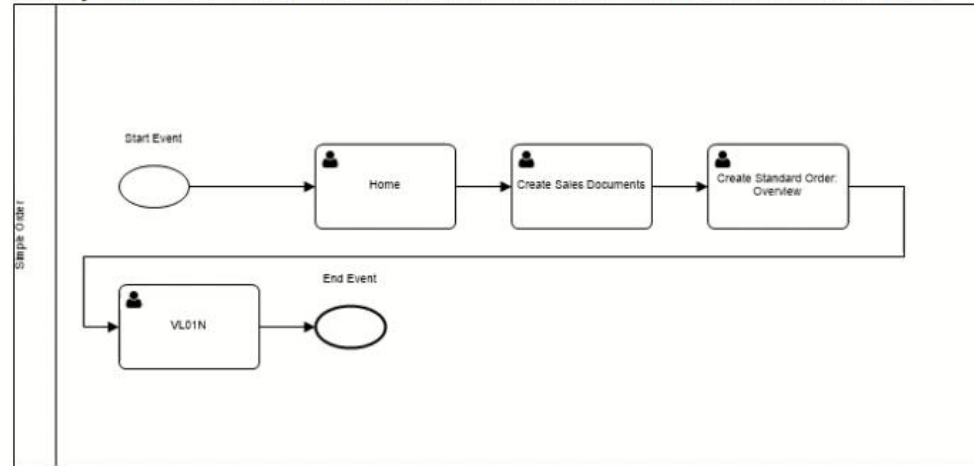

Home

**Window Name:** Home

Applied Filters  
→ Variant Unique

Order to Cash ▾



**Filters**

Clear All

**Variant**

**Unique**

1 6 - 6 9

- 6 + to - 6

Frequency

Duration ▾

Source ▾

Fixed Cost ▾

Variable Cost ▾

Activities ▾

Connections ▾

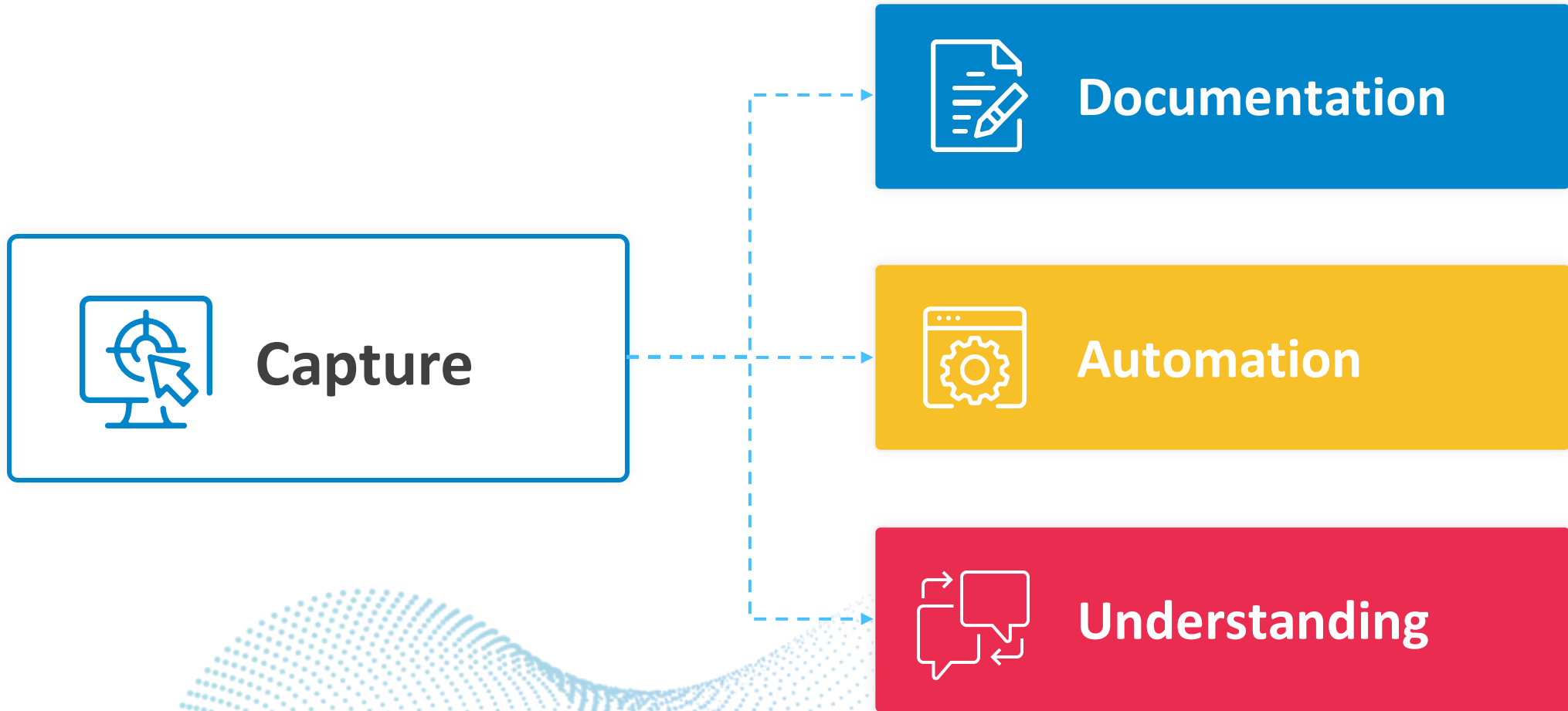

# Capture

Anyone can contribute with Capture

## Contributors:

- Manual testing of the Manual processes
- User Acceptance Testing
- Exploratory Testing
- Production user
- SME's or BA's
- New functions
- And more...

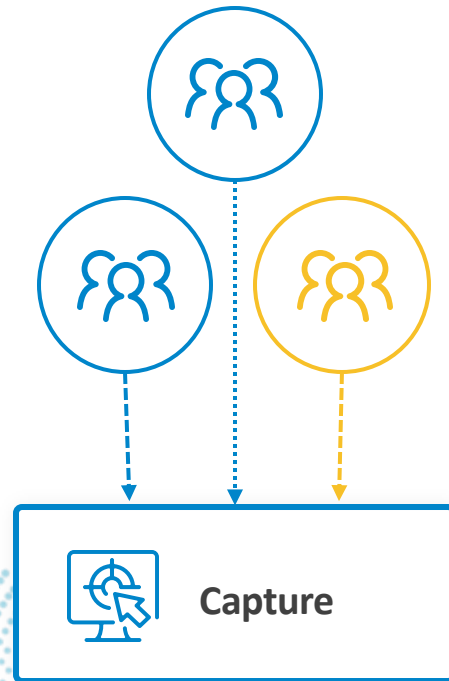

Documentation



Automation

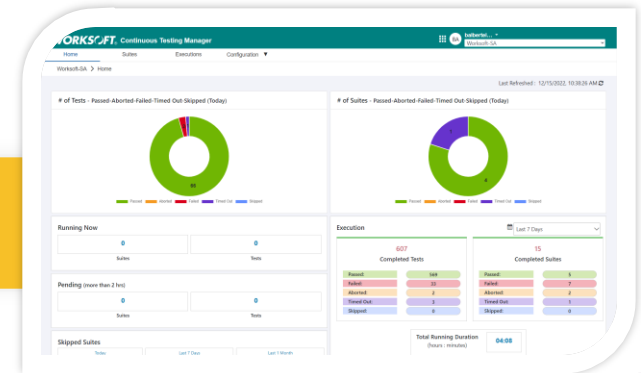

Understanding

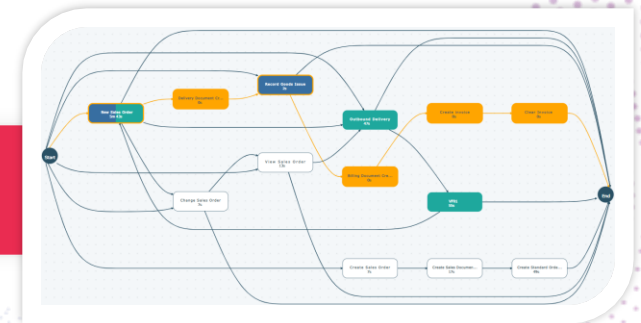



# Key Points

*People will accelerate your understanding of Process*

- Empower people to enable you understand as-is Processes across the business
  - *What processes migrate vs. improvement opportunities*
- Test during S/4 development & deployment
  - *Don't wait... Empower your people*

# The Truth about Test Cycle Speed, Defects and Coverage

*Wout Jacobs*

*Test Automation Architect*

*Dutch Railways*

# Dutch Railways

*The world's busiest rail network*



**WORKSOFT**<sup>®</sup>

- Defining the goals of Test Automation?
  - Test Faster (automation is faster than manual)
  - Coverage (automate earlier, automate more)
  - Detect Defects sooner to react quicker
- What should you aim to do?
  - Continuous Testing –finance, procurement, supply chain, logistics
  - Run's so "we don't have to look at it"
  - 8/9 am see the results, our test results are in can take action on the results quicker, every single day,

Last Refreshed : 10/15/2021, 7:01:36 AM

### # of Tests - Passed-Aborted-Failed-Timed Out-Skipped (Today)

No data to display.

### # of Suites - Passed-Aborted-Failed-Timed Out-Skipped (Today)

No data to display.

### Running Now

0

Suites

3

Tests

### Pending (more than 2 hrs)

0

Suites

0

Tests

### Execution

Last 7 Days

17

Completed Tests

Passed:	15
Failed:	2
Aborted:	0
Timed Out:	0
Skipped:	0

4

Completed Suites

Passed:	3
Failed:	1
Aborted:	0
Timed Out:	0
Skipped:	0





Worksoft CTM | https://ctm.worksoft.cloud/dashboard

**WORKSOFT** Continuous Testing Manager | balbertel... | Worksoft-SA

Home | Suites | Executions | Configuration

Worksoft-SA > Home

Last Refreshed : 1/19/2024, 10:33:03 PM

### # of Tests - Passed-Aborted-Failed-Timed Out-Skipped (Today)

Passed	8
Aborted	0
Failed	0
Timed Out	0
Skipped	0

### # of Suites - Passed-Aborted-Failed-Timed Out-Skipped (Today)

Passed	1
Aborted	0
Failed	0
Timed Out	0
Skipped	0

### Running Now

Suites	1
Tests	1

### Pending (more than 2 hrs)

Suites	0
Tests	0

### Execution

Last 7 Days

#### 438 Completed Tests

Passed:	68
Failed:	370
Aborted:	0
Timed Out:	0
Skipped:	0

#### 10 Completed Suites

Passed:	7
Failed:	3
Aborted:	0
Timed Out:	0
Skipped:	0

# AUTOMATION FOR TESTING – Parallel Execution



# Don't Wait for S/4 to Start Automating

*Jeenda Sri Ranjan*

*CEO & Co-Founder*

*ThreeRun – Working with BASF*

# ThreeRun

## *Managing Testing for BASF (Chemicals)*



- If I create automation on ECC, will it be wasted when I move to S/4HANA?
  - No! Don't delay, start automating today!
  - Only Worksoft can migrate automation assets from ECC (SAP GUI) to S/4HANA automatically

SAP Easy Access

Other menu Create role Assign users Documentation

- Favorites
- SAP Menu
  - Connector for Multi-Bank Connectivity
  - Office
  - Cross-Application Components
  - Logistics
  - Accounting
  - Human Resources
  - Patient Accounting
  - Information Systems
  - Customer Management
  - Tools
  - WebClient UI Framework

Execution

Run Step Skip Stop Capture Pause

Steps Variables Recordset Breakpoint

Step #	Log Status	Object Name	Action	Narrative	Interface Error Message
1	passed	Execution	Execute Process	Exec Process "App_Launch SAP GUI" at "First Step" use ""	
2		Execution	Execute Process	Exec Process "SAPGUI - Create Sales Order - VA01 - NI" at "First Step" use ""	
3		Execution	Execute Process	Exec Process "SAPGUI - Outbound Delivery - VL01N - NI" at "First Step" use ""	
4		Execution	Execute Process	Exec Process "SAPGUI - 1809 - Logoff - NI" at "First Step" use ""	

Process: EZE - OTC - SAPGUI

Exec...

Waiting for execution

Pause Cancel

# SAP GUI to FIORI Conversion



# Automation Speeds Implementation

*Christopher Pete*

*Automation Director*

*Ariel Corporation*



## Automation Speeds Implementation

Automated Testing Enables S/4 Go Live Ahead of Schedule

“We kicked off our SAP conversion in July of 2020. We had an estimated go live of around January, 2021. We were actually able to realize our go live much sooner. Rarely do you hear an SAP project going live earlier than what was initially planned. **One of the big factors that allowed us to really realize that was the fact that we had automated a lot of the testing.**”



CHRISTOPHER PETE  
ARIEL CORPORATION



**75%** TESTING  
FASTER

**2 Months** AHEAD OF  
SCHEDULE

# So what did we hear?

*Key themes from customer stories*

## Heather

- People for Process Knowledge

## Wout

- Speed, Coverage, Defects

## Jeenda

- Don't wait!
- ECC to S/4HANA script reusability

## Christopher

- Use automation as an accelerator during SAP Migration

# WORKSOFT® Connective Automation Platform

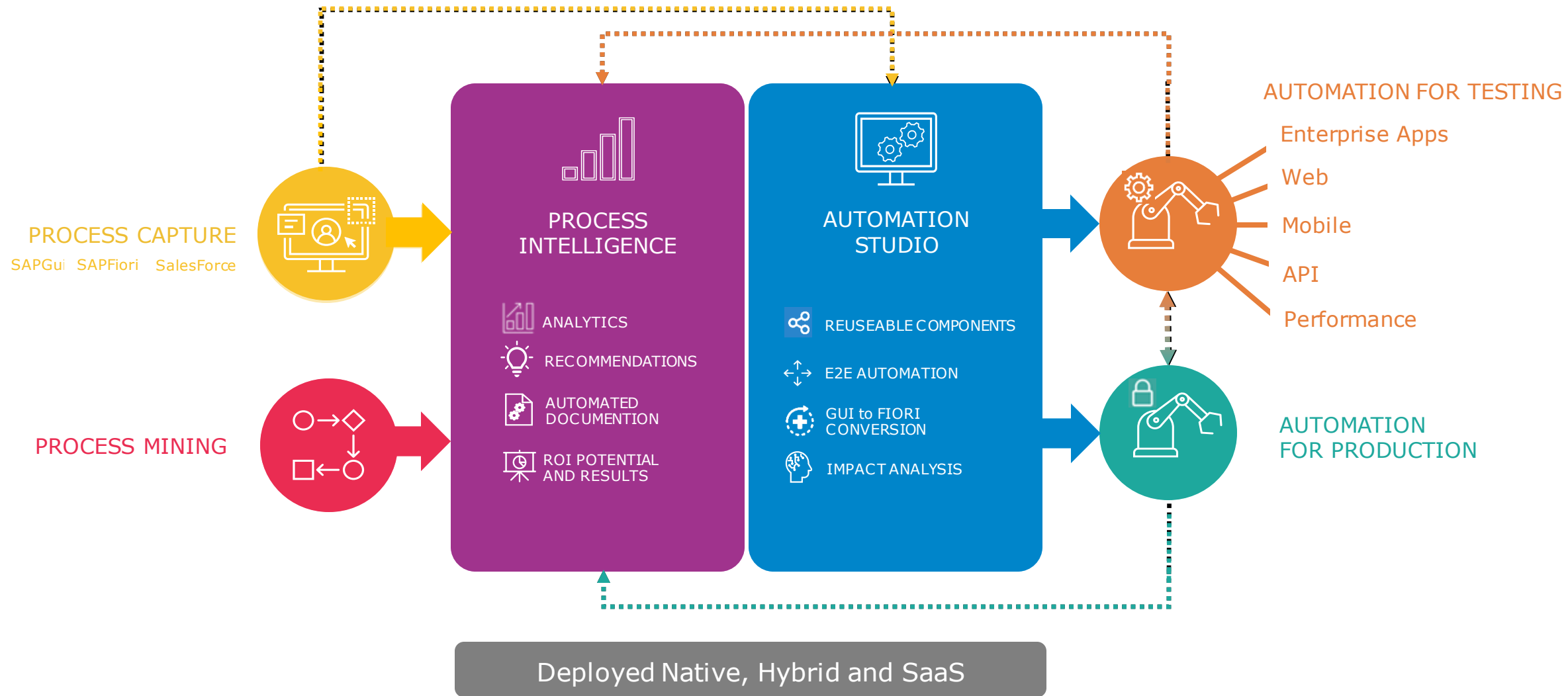



**WORKSOFT**® + PERFORCE

# What does this mean for our customers?



*Optimize experiences and provide E2E coverage across apps and devices with combined capabilities*

## Worksoft Delivers

- **Discover**
- **Test**
- **Automate**

## Perforce Delivers

- **Test Management & Traceability**
- **Mobile & Performance Testing**
- **Test Data Generation & Service Virtualization**

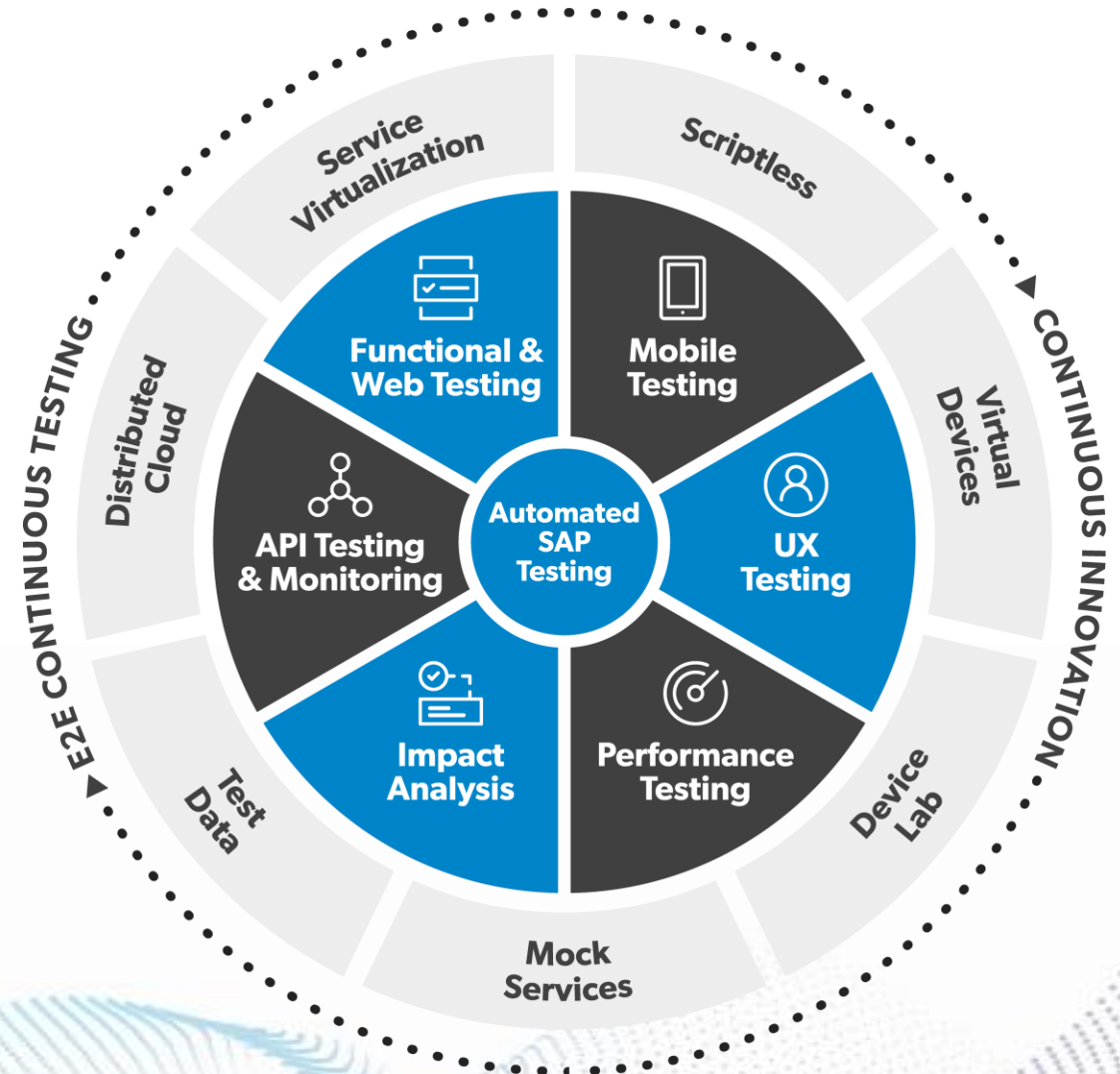





DISCOVER | TEST | AUTOMATE



THANK YOU

*Ty Henson* | [thenson@worksoft.com](mailto:thenson@worksoft.com)